



SPECIFICATION SHEET
S SERIES-14W-BI

S SERIES 14W - ADJUSTABLE & FIXED TRIMS

These sleek and stylish luminaires include the 14W tunable, 1018 lumen light engine. The S series delivers performance and beautiful aesthetics. Available in round and square faceplate options.



- DL** Dimmable Lighting
0 to 100% flicker free dimming
- TL** Tunable Lighting
- CRI 95+**
- Working Temperature**
-10°C to +40°C
- 5 Year Limited Warranty**
- California Title 24**
- UL US LISTED**

SPECIFICATIONS

Wattage	14 Watts					
Color Temperature	1800K - 4000K		2700K - 6500K		2200K - 5000K	
Beam Angle	20D	40D	20D	40D	20D	40D
Total Luminous Flux	700 lm	715 lm	935 lm	1018 lm	929 lm	990 lm
LED	COB				HEKA	
LED CRI	≥95Ra					
Input Voltage	48 Volts RJ45					
LM Rating	LM-80					
Trim Dimensions	Round Trim: Ø 3.38" / Ø 86mm Square Trim: 3.34" X 3.34" / 85 X 85mm					
Ceiling Cut-out	Round Trim: Ø 3.25" / Ø 83mm Square Trim: 3.21x3.21" / 81.7x81.7mm					
Certifications	cULus E476753, JA8 Title 24					
Compatible Decoder	DMX-SR-2112 Decoder					
Power Supply	PS-SR211296 - Power Supply 96W					
Working Temperature	-10C to 40C					
IP Grade	IP20 Standard					
Lifespan	50,000 Hours					
Warranty	5 Year Limited Warranty					

ROUND TRIM OPTIONS



SQUARE TRIM OPTIONS



BIANCA 14W BULB



BULB DIMENSIONS

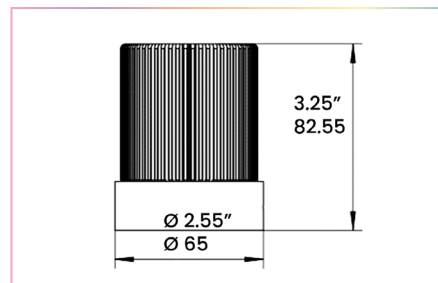

S SERIES – ROUND TRIMS

S-200-11-11 / Round Adjustable Trim



TRIM / REFLECTOR FINISH

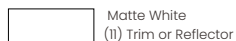

OPTICS

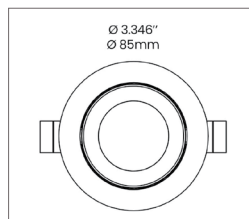
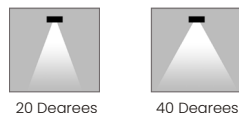

APERTURE
Ø 1.75" / 44.45mm

TRIM
Ø 3.346" / 85mm

MODEL CODES
S-200-11-11-14W-BI18-40K-40-IP20
S-200-11-11-14W-BI18-40K-20-IP20
S-200-11-11-14W-BI27-65K-40-IP20
S-200-11-11-14W-BI27-65K-20-IP20
S-200-11-11-14W-BI22-50K-40-IP20
S-200-11-11-14W-BI22-50K-20-IP20

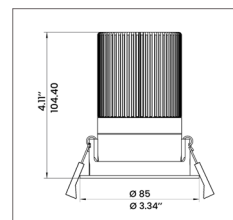

S-300-11-11 | S-300-11-05 / Round Fixed Trim



TRIM / REFLECTOR FINISH



OPTICS

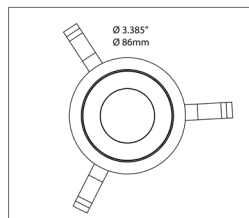
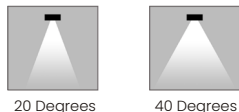

MODEL CODES / Chrome Reflector

S-300-11-05-14W-BI18-40K-40-IP20
S-300-11-05-14W-BI18-40K-20-IP20
S-300-11-05-14W-BI27-65K-40-IP20
S-300-11-05-14W-BI27-65K-20-IP20
S-300-11-05-14W-BI22-50K-40-IP20
S-300-11-05-14W-BI22-50K-20-IP20

MODEL CODES / White Reflector
S-300-11-11-14W-BI18-40K-40-IP20
S-300-11-11-14W-BI18-40K-20-IP20
S-300-11-11-14W-BI27-65K-40-IP20
S-300-11-11-14W-BI27-65K-20-IP20
S-300-11-11-14W-BI22-50K-40-IP20
S-300-11-11-14W-BI22-50K-20-IP20

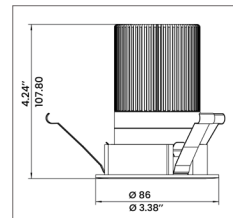

S-340-11-11 | S-340-11-05 / Round Adjustable Trim



TRIM / REFLECTOR FINISH



OPTICS

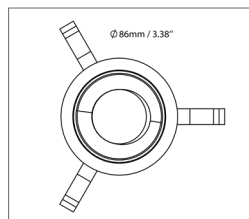
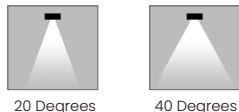

MODEL CODES / Chrome Reflector

S-340-11-05-14W-BI18-40K-40-IP20
S-340-11-05-14W-BI18-40K-20-IP20
S-340-11-05-14W-BI27-65K-40-IP20
S-340-11-05-14W-BI27-65K-20-IP20
S-340-11-05-14W-BI22-50K-40-IP20
S-340-11-05-14W-BI22-50K-20-IP20

MODEL CODES / White Reflector
S-340-11-11-14W-BI18-40K-40-IP20
S-340-11-11-14W-BI18-40K-20-IP20
S-340-11-11-14W-BI27-65K-40-IP20
S-340-11-11-14W-BI27-65K-20-IP20
S-340-11-11-14W-BI22-50K-40-IP20
S-340-11-11-14W-BI22-50K-20-IP20

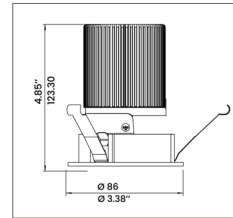

S SERIES – ROUND TRIMS

S-350-11-11 / Round Adjustable Trim



TRIM FINISH



OPTICS

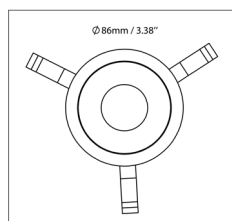

APERTURE
Ø 1.25" / 31.75mm

TRIM
Ø 3.38" / 86mm

MODEL CODES
S-350-11-11-14W-BI18-40K-40-IP20
S-350-11-11-14W-BI18-40K-20-IP20
S-350-11-11-14W-BI27-65K-40-IP20
S-350-11-11-14W-BI27-65K-20-IP20
S-350-11-11-14W-BI22-50K-40-IP20
S-350-11-11-14W-BI22-50K-20-IP20

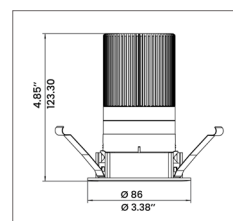

S-360-11-11 / Round Adjustable Trim



TRIM FINISH



OPTICS

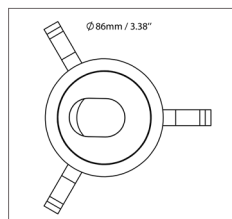

APERTURE
Ø 1.06" / 27.2mm

TRIM
Ø 3.385" / 86mm

MODEL CODES
S-360-11-11-14W-BI18-40K-40-IP20
S-360-11-11-14W-BI18-40K-20-IP20
S-360-11-11-14W-BI27-65K-40-IP20
S-360-11-11-14W-BI27-65K-20-IP20
S-360-11-11-14W-BI22-50K-40-IP20
S-360-11-11-14W-BI22-50K-20-IP20

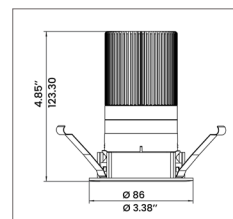

S SERIES – ROUND TRIMLESS

S-300-11-11-TL | S-300-11-05-TL / Round Fixed Trimless



TRIMLESS / REFLECTOR FINISH



OPTICS



APERTURE
Ø 1.5" / 38.1mm

TRIMLESS
4.72" X 4.72" / 120 X 120mm

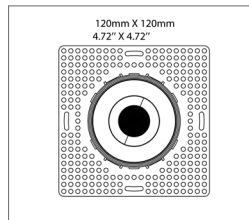

MODEL CODES / Chrome Reflector

S-300-11-05-TL-14W-BI18-40K-40-IP20
S-300-11-05-TL-14W-BI18-40K-20-IP20
S-300-11-05-TL-14W-BI27-65K-40-IP20
S-300-11-05-TL-14W-BI27-65K-20-IP20
S-300-11-05-TL-14W-BI22-50K-40-IP20
S-300-11-05-TL-14W-BI22-50K-20-IP20

MODEL CODES / White Reflector
S-300-11-11-TL-14W-BI18-40K-40-IP20
S-300-11-11-TL-14W-BI18-40K-20-IP20
S-300-11-11-TL-14W-BI27-65K-40-IP20
S-300-11-11-TL-14W-BI27-65K-20-IP20
S-300-11-11-TL-14W-BI22-50K-40-IP20
S-300-11-11-TL-14W-BI22-50K-20-IP20

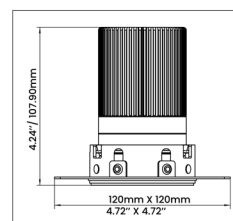

S SERIES - ROUND TRIMLESS

S-340-11-11-TL | S-340-11-05-TL / Round Adjustable Trimless



TRIMLESS / REFLECTOR FINISH



OPTICS



APERTURE
Ø 1.75" / 44.45mm

TRIMLESS
4.72"x4.72" / 120 X 120mm

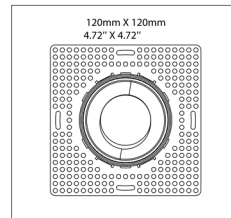

MODEL CODES / Chrome Reflector

S-340-11-05-TL-14W-BI18-40K-40-IP20
S-340-11-05-TL-14W-BI18-40K-20-IP20
S-340-11-05-TL-14W-BI27-65K-40-IP20
S-340-11-05-TL-14W-BI27-65K-20-IP20
S-340-11-05-TL-14W-BI22-50K-40-IP20
S-340-11-05-TL-14W-BI22-50K-20-IP20

MODEL CODES / White Reflector

S-340-11-11-TL-14W-BI18-40K-40-IP20
S-340-11-11-TL-14W-BI18-40K-20-IP20
S-340-11-11-TL-14W-BI27-65K-40-IP20
S-340-11-11-TL-14W-BI27-65K-20-IP20
S-340-11-11-TL-14W-BI22-50K-40-IP20
S-340-11-11-TL-14W-BI22-50K-20-IP20

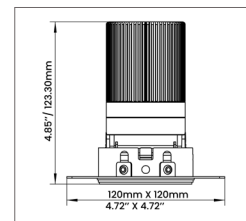

S-350-11-11-TL / Round Adjustable Trimless



TRIMLESS FINISH



OPTICS

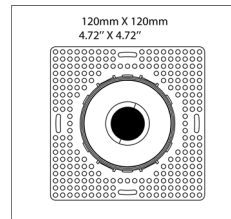
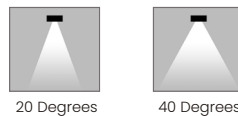

APERTURE
Ø 1.25" / 31.75mm

TRIMLESS
4.72"x4.72" / 120 X 120mm

MODEL CODES

S-350-11-11-TL-14W-BI18-40K-40-IP20
S-350-11-11-TL-14W-BI18-40K-20-IP20
S-350-11-11-TL-14W-BI27-65K-40-IP20
S-350-11-11-TL-14W-BI27-65K-20-IP20
S-350-11-11-TL-14W-BI22-50K-40-IP20
S-350-11-11-TL-14W-BI22-50K-20-IP20

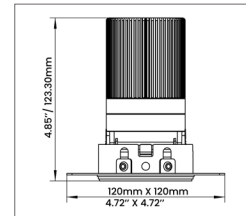

S-360-11-11-TL / Round Adjustable Trimless



TRIMLESS FINISH



OPTICS

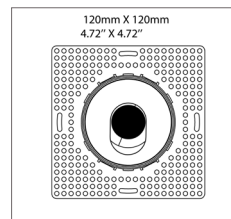
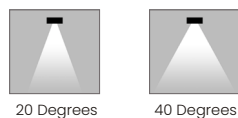

APERTURE
Ø 1.06" / 22.7mm

TRIMLESS
4.72"x4.72" / 120 X 120mm

MODEL CODES

S-360-11-11-TL-14W-BI18-40K-40-IP20
S-360-11-11-TL-14W-BI18-40K-20-IP20
S-360-11-11-TL-14W-BI27-65K-40-IP20
S-360-11-11-TL-14W-BI27-65K-20-IP20
S-360-11-11-TL-14W-BI22-50K-40-IP20
S-360-11-11-TL-14W-BI22-50K-20-IP20

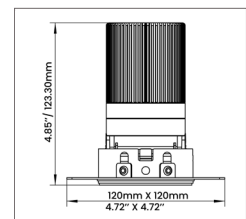

S SERIES – SQUARE TRIMS

S-500-11-11 | S-500-11-05 / Square Fixed Trim



TRIM / REFLECTOR FINISH



OPTICS



20 Degrees



40 Degrees

APERTURE

Ø 1.5" / 38.1mm

TRIM

3.34" X 3.34"
85 X 85mm

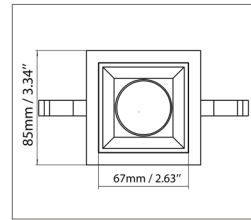

MODEL CODES/ Chrome Reflector

S-500-11-05-14W-BI18-40K-40-IP20
S-500-11-05-14W-BI18-40K-20-IP20
S-500-11-05-14W-BI27-65K-40-IP20
S-500-11-05-14W-BI27-65K-20-IP20
S-500-11-05-14W-BI22-50K-40-IP20
S-500-11-05-14W-BI22-50K-20-IP20

MODEL CODES/ White Reflector

S-500-11-11-14W-BI18-40K-40-IP20
S-500-11-11-14W-BI18-40K-20-IP20
S-500-11-11-14W-BI27-65K-40-IP20
S-500-11-11-14W-BI27-65K-20-IP20
S-500-11-11-14W-BI22-50K-40-IP20
S-500-11-11-14W-BI22-50K-20-IP20

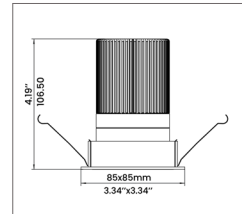

S-540-11-11 | S-540-11-05 / Square Adjustable Trim



TRIM / REFLECTOR FINISH



OPTICS



20 Degrees



40 Degrees

APERTURE

Ø 1.5" / 38.1mm

TRIM

3.34" X 3.34"
85 X 85mm

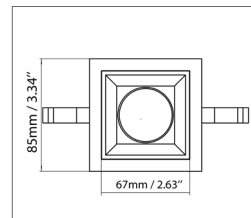

MODEL CODES/ Chrome Reflector

S-540-11-05-14W-BI18-40K-40-IP20
S-540-11-05-14W-BI18-40K-20-IP20
S-540-11-05-14W-BI27-65K-40-IP20
S-540-11-05-14W-BI27-65K-20-IP20
S-540-11-05-14W-BI22-50K-40-IP20
S-540-11-05-14W-BI22-50K-20-IP20

MODEL CODES/ White Reflector

S-540-11-11-14W-BI18-40K-40-IP20
S-540-11-11-14W-BI18-40K-20-IP20
S-540-11-11-14W-BI27-65K-40-IP20
S-540-11-11-14W-BI27-65K-20-IP20
S-540-11-11-14W-BI22-50K-40-IP20
S-540-11-11-14W-BI22-50K-20-IP20

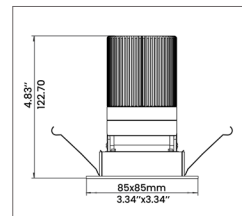

S SERIES – SQUARE TRIMS

S-500-11-11-TL | S-500-11-05-TL / Square Fixed Trimless

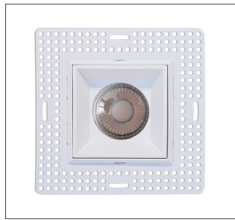

TRIMLESS / REFLECTOR FINISH

-  Matte White
(11) Trimless or Reflector
-  Chrome
(05) Reflector



OPTICS



20 Degrees



40 Degrees

APERTURE

Ø 1.5" / 38.1mm

TRIMLESS

4.72" X 4.72" / 120 X 120mm

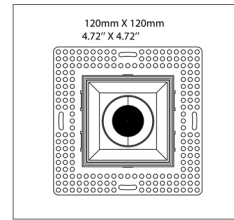

MODEL CODES/ Chrome Reflector
S-500-11-05-TL-14W-BI18-40K-40-IP20
S-500-11-05-TL-14W-BI18-40K-20-IP20
S-500-11-05-TL-14W-BI27-65K-40-IP20
S-500-11-05-TL-14W-BI27-65K-20-IP20
S-500-11-05-TL-14W-BI22-50K-40-IP20
S-500-11-05-TL-14W-BI22-50K-20-IP20

MODEL CODES/ White Reflector
S-500-11-11-TL-14W-BI18-40K-40-IP20
S-500-11-11-TL-14W-BI18-40K-20-IP20
S-500-11-11-TL-14W-BI27-65K-40-IP20
S-500-11-11-TL-14W-BI27-65K-20-IP20
S-500-11-11-TL-14W-BI22-50K-40-IP20
S-500-11-11-TL-14W-BI22-50K-20-IP20

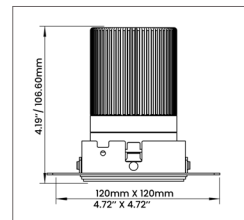

S-540-11-11-TL | S-540-11-05-TL / Square Adjustable Trimless



TRIMLESS / REFLECTOR FINISH

-  Matte White
(11) Trimless or Reflector
-  Chrome
(05) Reflector



OPTICS



20 Degrees



40 Degrees

APERTURE

Ø 1.5" / 38.1mm

TRIMLESS

4.72" X 4.72" / 120 X 120mm

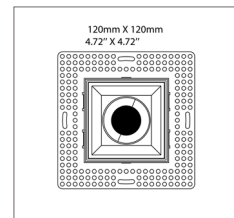

MODEL CODES/ Chrome Reflector
S-540-11-05-TL-14W-BI18-40K-40-IP20
S-540-11-05-TL-14W-BI18-40K-20-IP20
S-540-11-05-TL-14W-BI27-65K-40-IP20
S-540-11-05-TL-14W-BI27-65K-20-IP20
S-540-11-05-TL-14W-BI22-50K-40-IP20
S-540-11-05-TL-14W-BI22-50K-20-IP20

MODEL CODES/ White Reflector
S-540-11-11-TL-14W-BI18-40K-40-IP20
S-540-11-11-TL-14W-BI18-40K-20-IP20
S-540-11-11-TL-14W-BI27-65K-40-IP20
S-540-11-11-TL-14W-BI27-65K-20-IP20
S-540-11-11-TL-14W-BI22-50K-40-IP20
S-540-11-11-TL-14W-BI22-50K-20-IP20

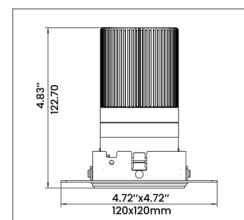

COMPATIBLE DECODER



DMX DECODER
DMX-SR-2112

COMPATIBLE POWER SUPPLY



POWER SUPPLY
PS-SR2112-96



HOUSING FOR ROUND TRIM

Housing - Round Trim	S-9W-HSG-RD
Ceiling Cut-out	Ø 3.25" / Ø 83mm
Ceiling Thickness	½" to 1 ½" / 12.7mm to 38.1mm

OVERALL DIMENSIONS

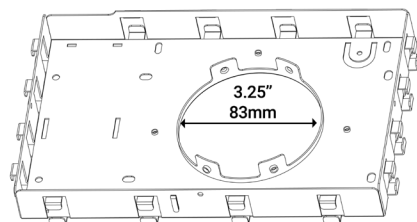
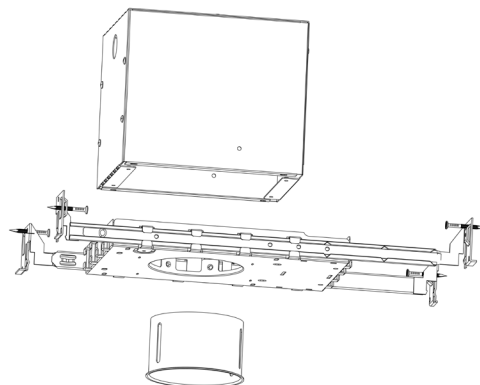
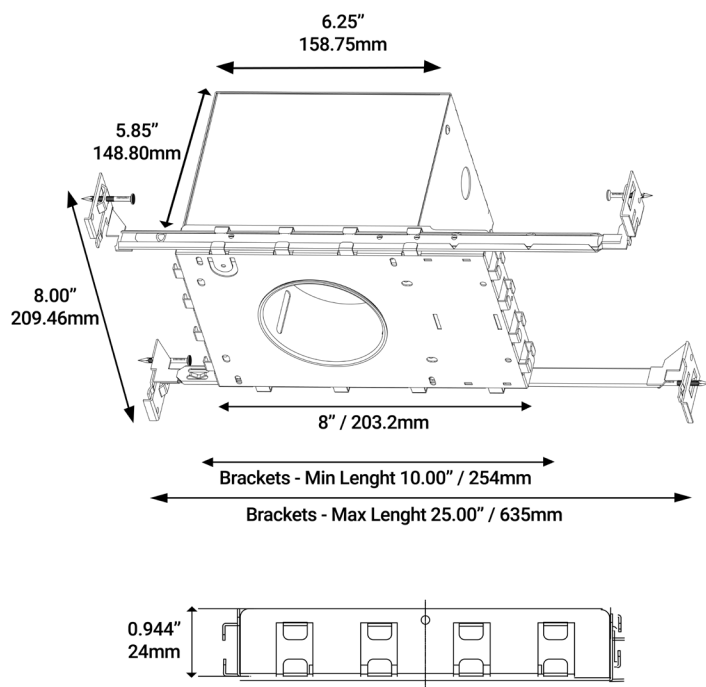

Length:	8 Inch / 203mm
Height:	5.85 Inch / 148.80mm
Width:	6.25 Inch / 158.75mm
Adjustable Brackets:	Max: 25 Inch / 635mm Min: 10 Inch / 254mm

HOUSING FOR SQUARE TRIM

Housing - Round Trim	S-9W-HSG-SQ
Ceiling Cut-out	3.21"x3.21" / 81.7x81.7mm
Ceiling Thickness	½" to 1 ½" / 12.7mm to 38.1mm

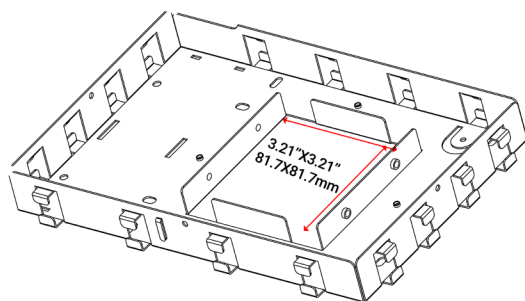
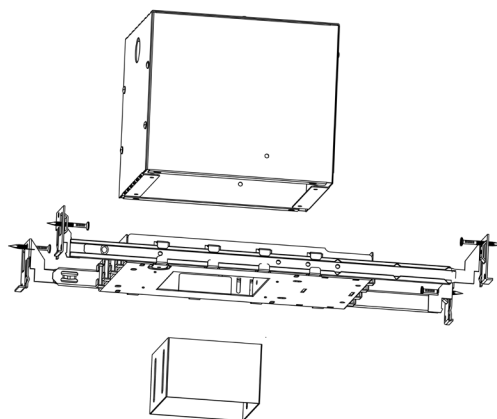
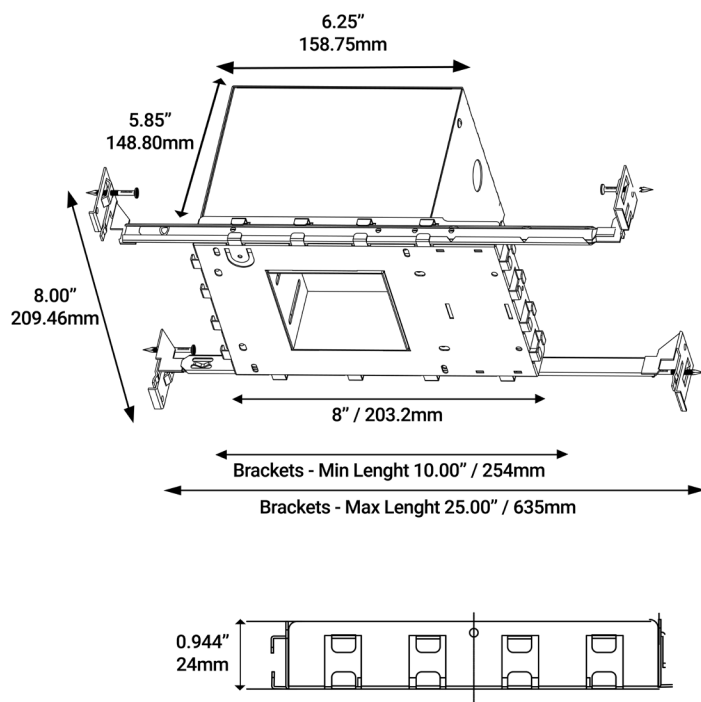
OVERALL DIMENSIONS

Length:	8 Inch / 203mm
Height:	5.85 Inch / 148.80mm
Width:	6.25 Inch / 158.75mm
Adjustable Brackets:	Max: 25 Inch / 635mm Min: 10 Inch / 254mm

PHOTOMETRIC INFORMATION / 20D

COLOR TEMPERATURE / 1800K - 4000K

Luminous Intensity Distribution Curve

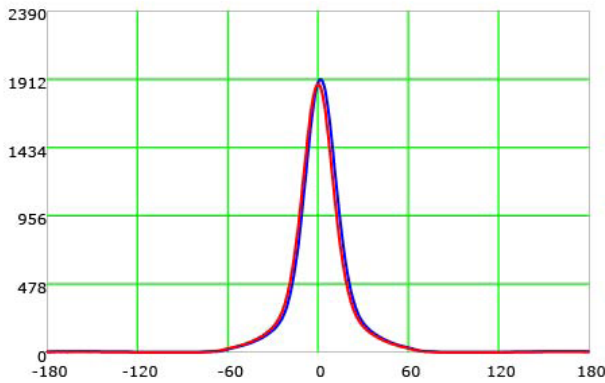
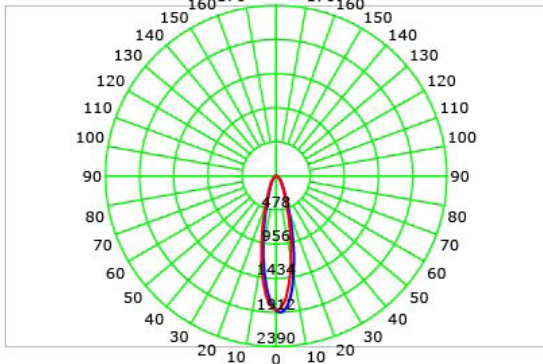

Illuminance at a Distance

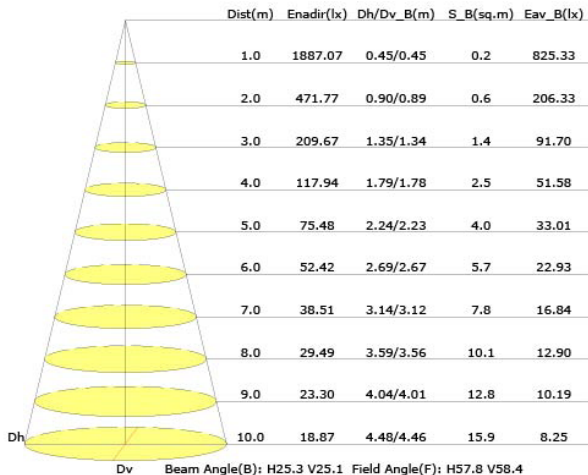

PHOTOMETRIC INFORMATION / 40D

COLOR TEMPERATURE / 1800K - 4000K

Luminous Intensity Distribution Curve

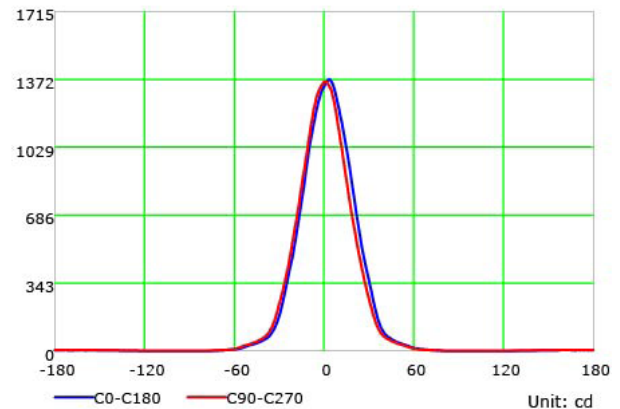
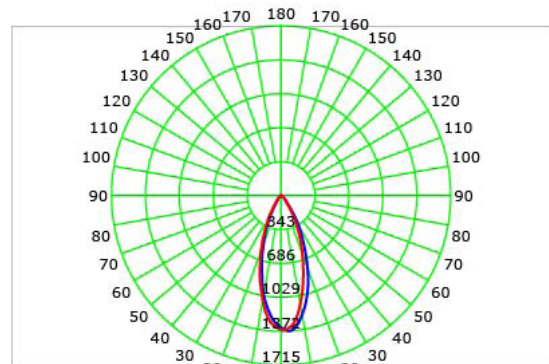

Illuminance at a Distance

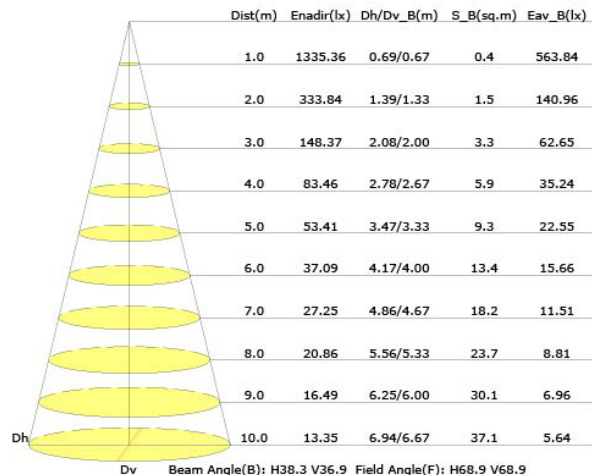

PHOTOMETRIC INFORMATION / 20D

COLOR TEMPERATURE / 2700K - 6500K

Luminous Intensity Distribution Curve

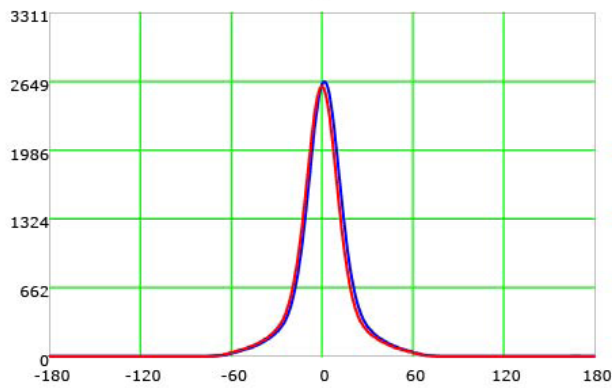
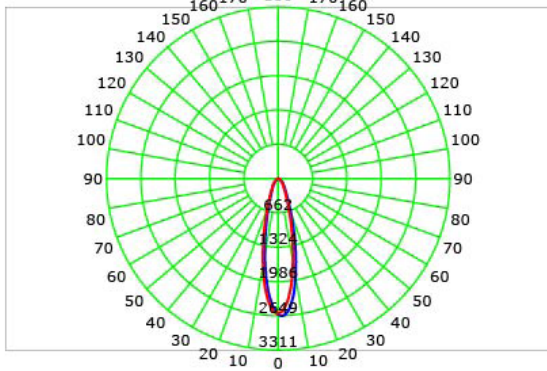

Illuminance at a Distance

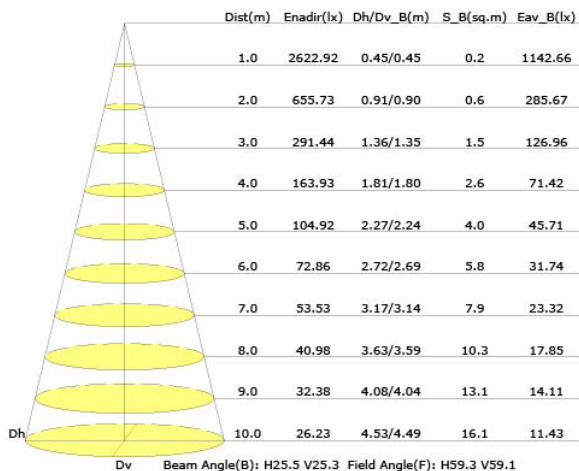

PHOTOMETRIC INFORMATION / 40D

COLOR TEMPERATURE / 2700K - 6500K

Luminous Intensity Distribution Curve

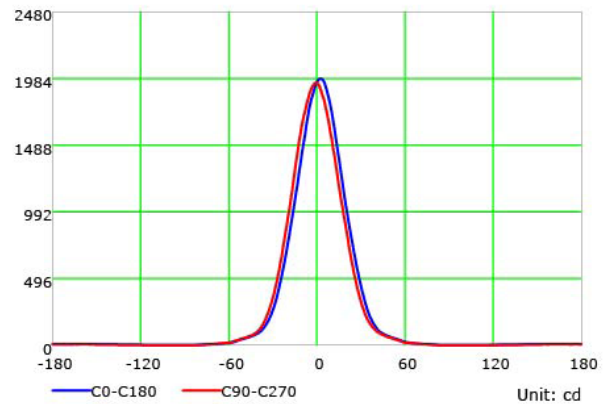
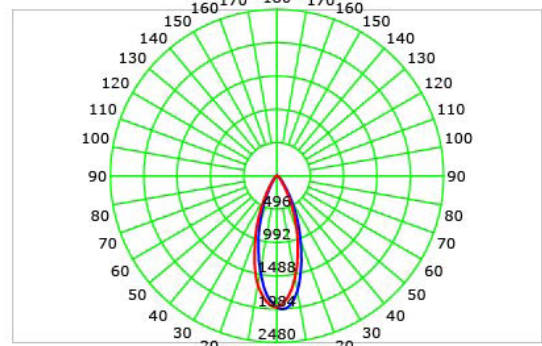

Illuminance at a Distance

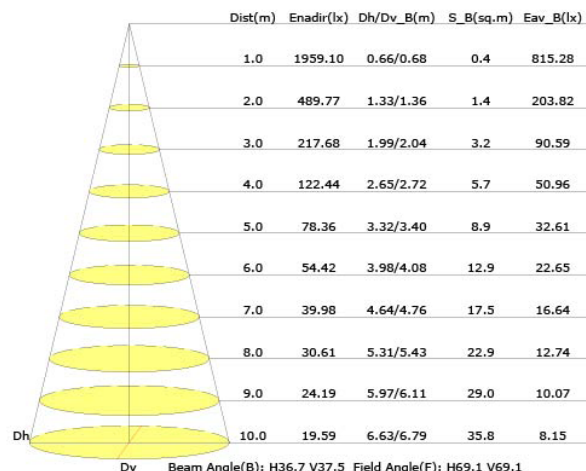

PHOTOMETRIC INFORMATION / 20D

COLOR TEMPERATURE / 2200K - 5000K

Luminous Intensity Distribution Curve

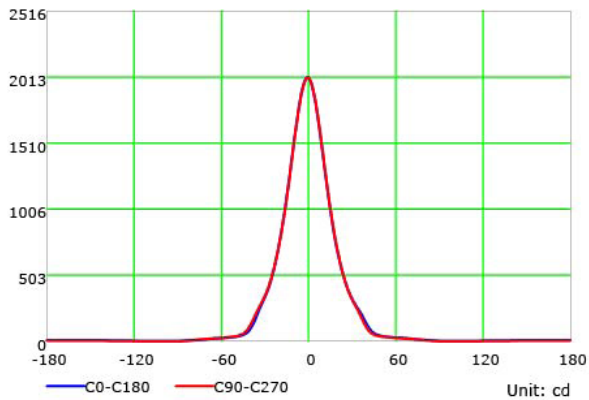
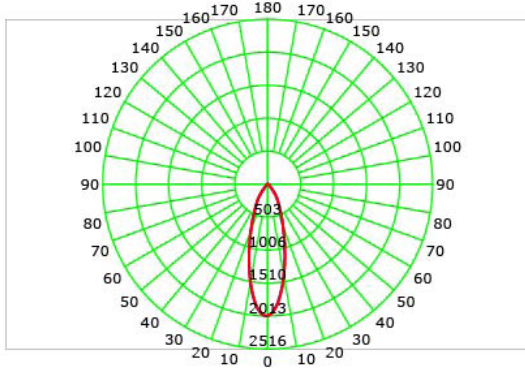

ILLUMINANCE AT A DISTANCE

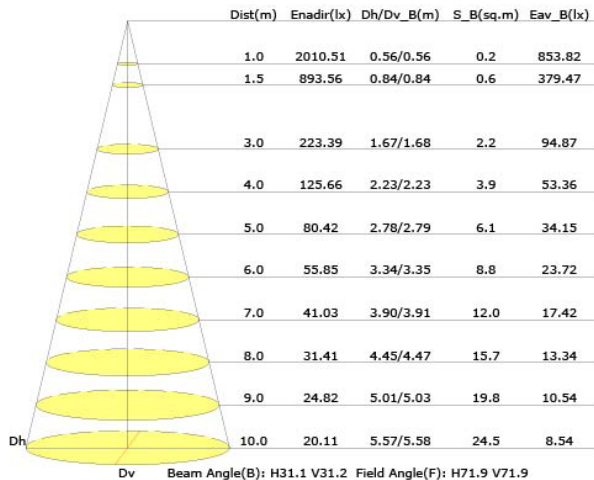

PHOTOMETRIC INFORMATION / 40D

COLOR TEMPERATURE / 2200K - 5000K

Luminous Intensity Distribution Curve

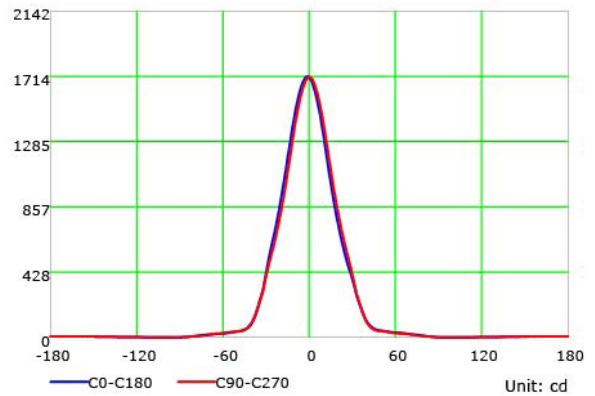
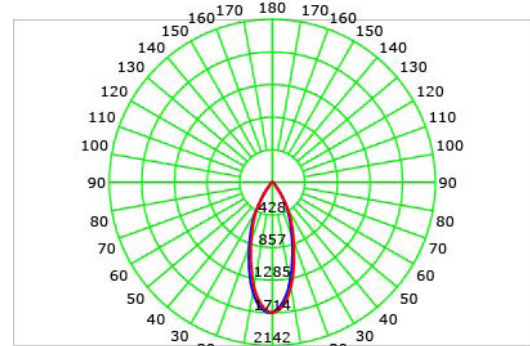

ILLUMINANCE AT A DISTANCE

