

TEGA-DR-SERIES - PATHWAY LIGHTING

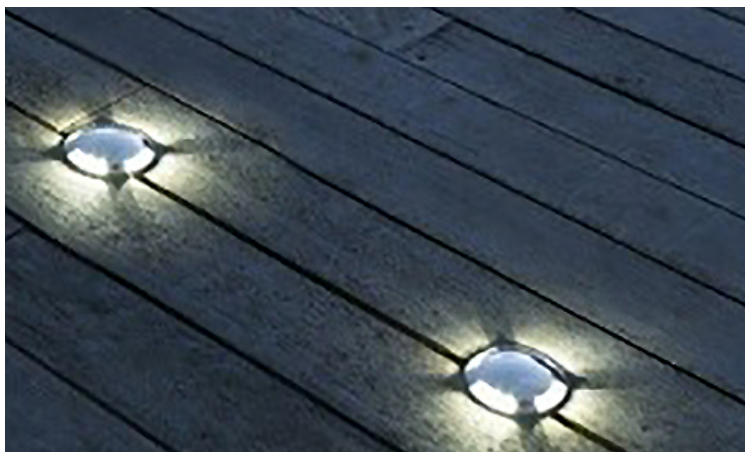

PRODUCT CODES	
TEGA-DR-9W-BR-18-40K-20-4S	TEGA-DR-9W-BR-18-40K-40-4S
TEGA-DR-9W-BR-27-65K-20-4S	TEGA-DR-9W-BR-27-65K-40-4S
TEGA-DR-9W-BR-22-50K-20-4S	TEGA-DR-9W-BR-22-50K-40-4S
TEGA-DR-10W-RGBW-20-4S	TEGA-DR-10W-RGBW-40-4S

FRONT VIEW



DIMENSIONS

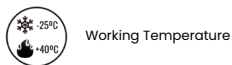
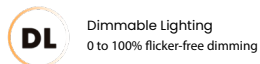
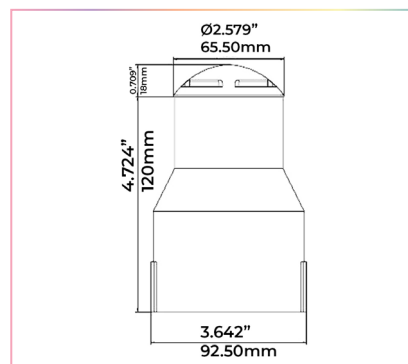

1800K to 4000K

2200K to 5000K

2700K to 6500K

RGBW

SPECIFICATIONS

Wattage	9 Watts	10 Watts
Beam Angle	4 sides 60°	
LED CRI	≥95Ra	
Input Voltage	48 Volts, RJ45	
LED Type	CTM-9 /Luminus	
Housing material	Front cover : Stainless steel + Heatsink: Aluminum	
Dimensions	Ø65.50*H120 mm	
Certifications	cULus	
Compatible Decoder	DMX-SR2112	
Power Supply	PS-SR2112-96	
Working Temperature	-25C to 40C	
IP Grade	IP67	
Lifespan	50,000 Hours	
Warranty	3 Year Limited Warranty	

PHOTOMETRIC INFORMATION / 20D

COLOR TEMPERATURE / 1800K - 4000K

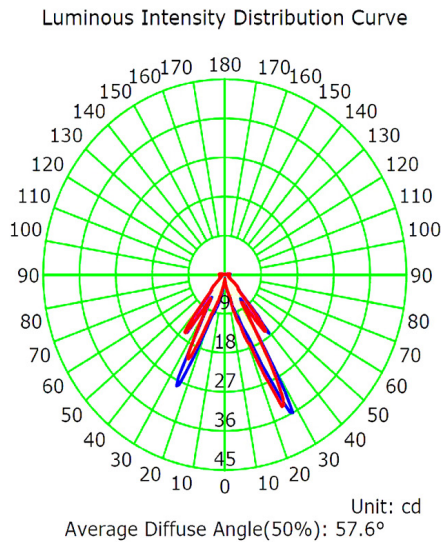

Illuminance at a Distance

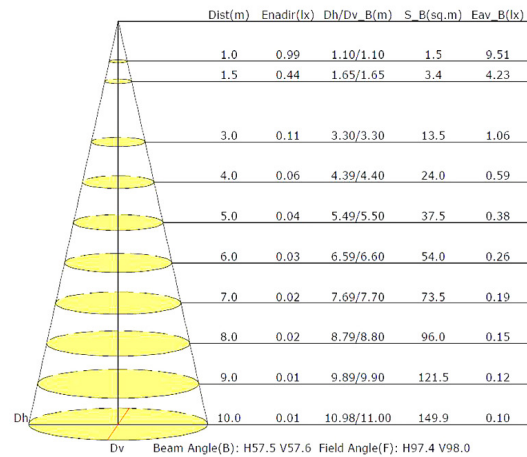

PHOTOMETRIC INFORMATION / 40D

COLOR TEMPERATURE / 1800K - 4000K

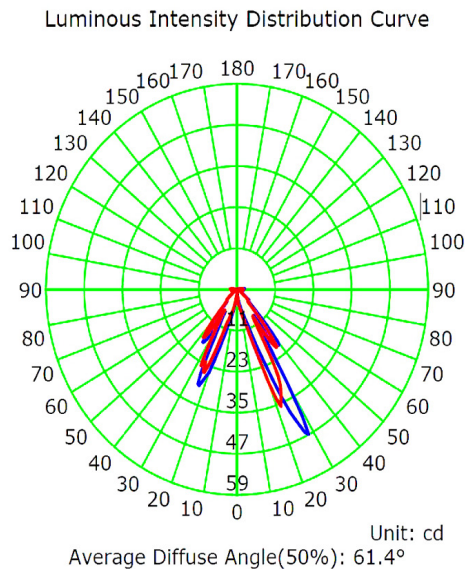

Illuminance at a Distance

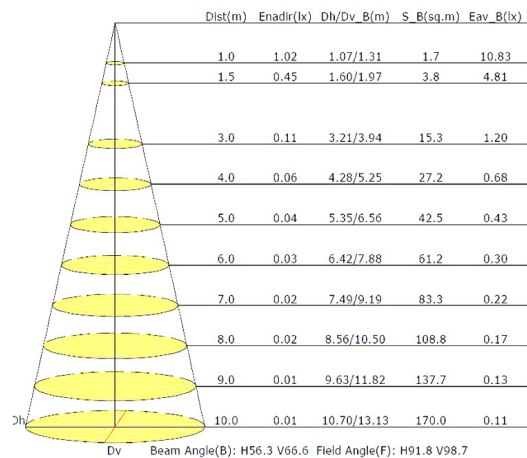

PHOTOMETRIC INFORMATION / 20D

COLOR TEMPERATURE / 2700K - 6500K

Luminous Intensity Distribution Curve

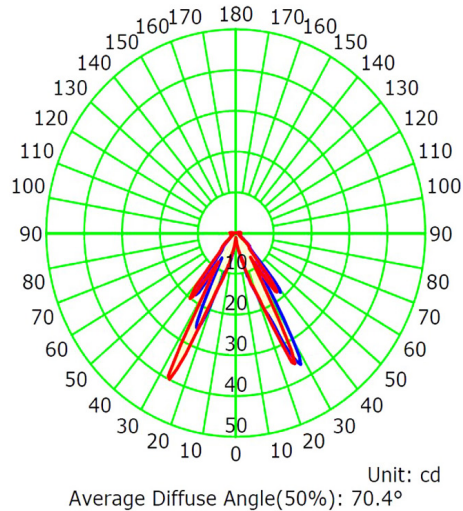

Illuminance at a Distance

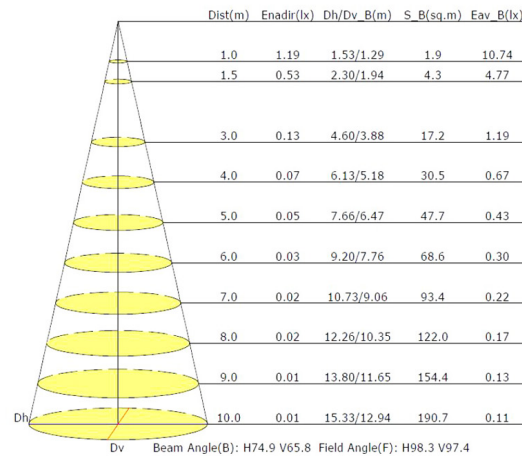

PHOTOMETRIC INFORMATION / 40D

COLOR TEMPERATURE / 2700K - 6500K

Luminous Intensity Distribution Curve

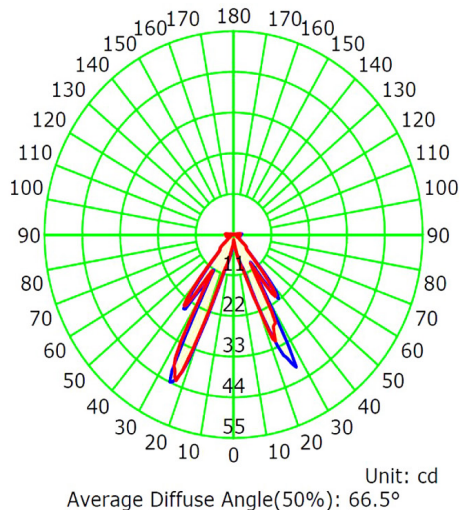

Illuminance at a Distance

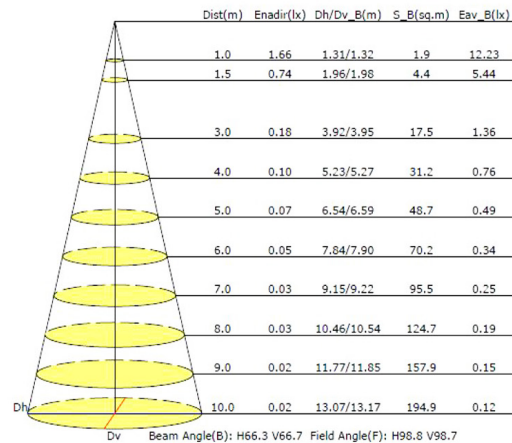

PHOTOMETRIC INFORMATION / 40D

COLOR TEMPERATURE / RGBW

Luminous Intensity Distribution Curve

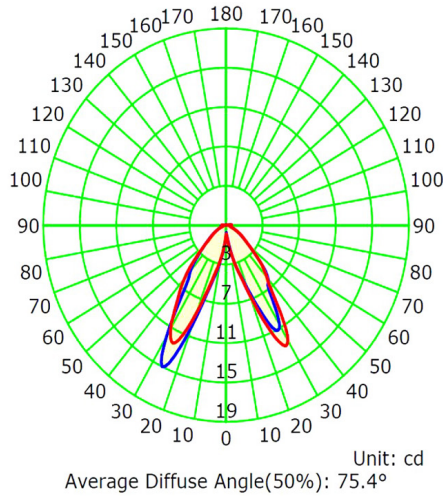

Illuminance at a Distance

